

## DPP – 1 (NLM)

Video Solution on Website:-

<https://physicsaholics.com/home/courseDetails/53>

Video Solution on YouTube:-

<https://youtu.be/bzzArA15vcQ>

Written Solution on Website:-

<https://physicsaholics.com/note/notesDetails/75>

- Q 1. Draw FBD of both pulleys, man and block:  
(pulleys are massless)

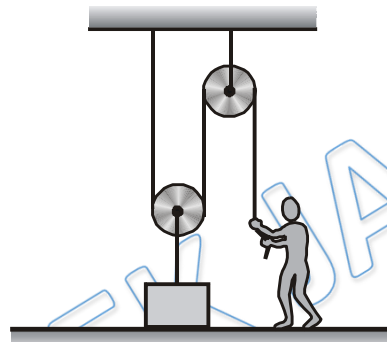

- Q 2. Draw FBD of block of mass  $m$ :

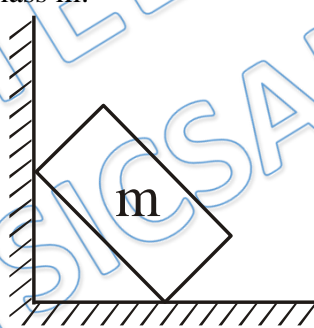

All surface smooth

- Q 3. Draw FBD of block of mass  $m$ :

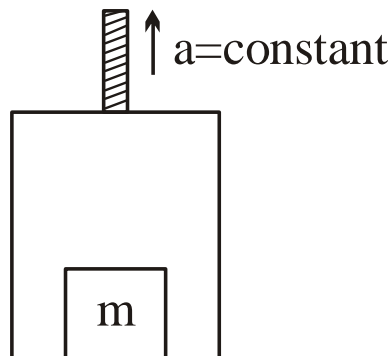

- Q 4. Draw FBD of both the blocks  
(all surfaces are smooth)

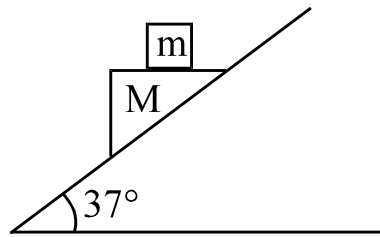

Q 5. Draw FBD of all spheres:

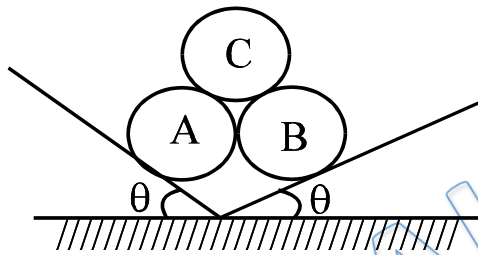

Q 6. Draw FBD of rod A:

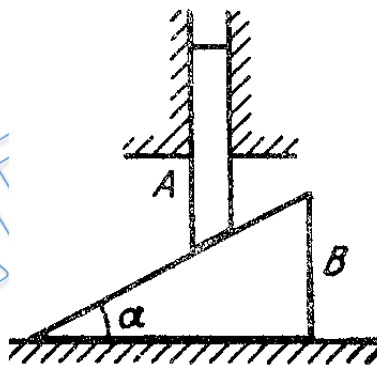

Q 7. Draw FBD of man and cabin:

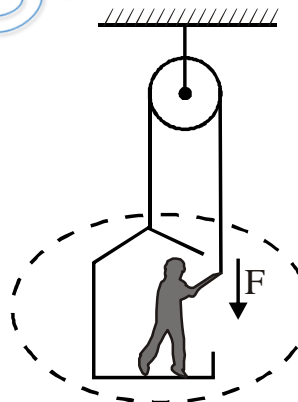

Q 8. Draw FBD of all three blocks & wedge:

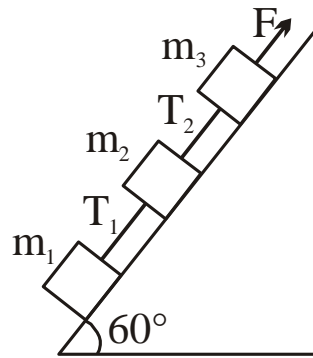

Q 9. Draw FBD of block of mass  $2M$  & Pulley B:

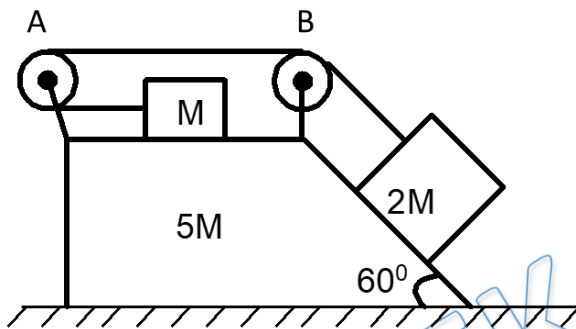

Q 10. Draw FBD of block C and pulley 2:

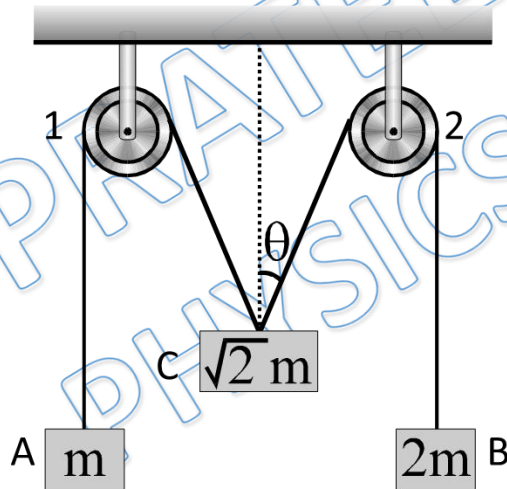

NEET UG subscription

PLUS **ICONIC\*\***

- ✓ India's Best Educators
- ✓ Interactive Live Classes
- ✓ Structured Courses & PDFs
- ✓ Live Tests & Quizzes
- ✗ Personal Coach
- ✗ Study Planner

24 months ₹2,100/mo >  
No cost EMI +10% OFF ₹50,400

18 months ₹2,363/mo >  
No cost EMI +10% OFF ₹42,525

12 months ₹2,888/mo >  
No cost EMI +10% OFF ₹34,650

6 months ₹4,200/mo >  
No cost EMI +10% OFF ₹25,200

To be paid as a one-time payment

[View all plans](#)



Awesome! **PHYSICSLIVE** code applied



# PHYSICSLIVE

Use code **PHYSICSLIVE** to get 10% OFF on Unacademy PLUS and learn from India's Top Faculties.

NEET UG subscription

PLUS **ICONIC\*\***

- ✓ India's Best Educators
- ✓ Interactive Live Classes
- ✓ Structured Courses & PDFs
- ✓ Live Tests & Quizzes
- ✗ Personal Coach
- ✗ Study Planner

24 months ₹2,100/mo >  
No cost EMI +10% OFF ₹50,400

18 months ₹2,363/mo >  
No cost EMI +10% OFF ₹42,525

12 months ₹2,888/mo >  
No cost EMI +10% OFF ₹34,650

6 months ₹4,200/mo >  
No cost EMI +10% OFF ₹25,200

To be paid as a one-time payment

[View all plans](#)



Awesome! **PHYSICSLIVE** code applied



# Written Solution

**DPP- 1 NLM of Motion Free Body Diagram**

**By Physicsaholics Team**

# Solution: 1

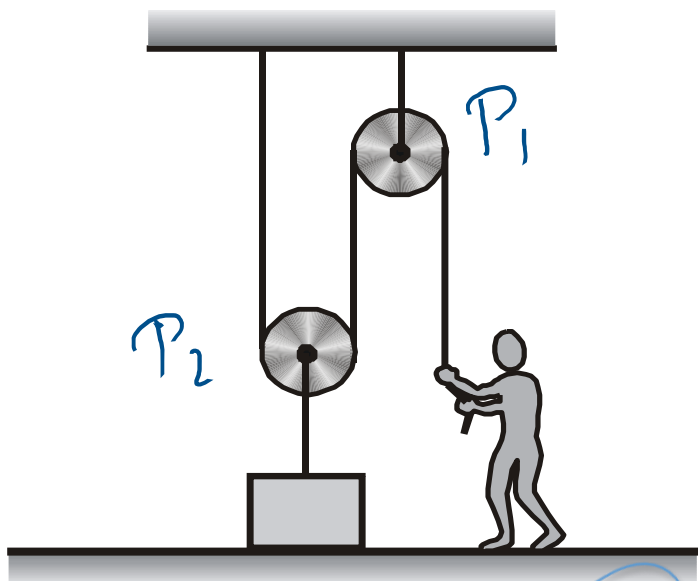

F.B.D of  $P_1$

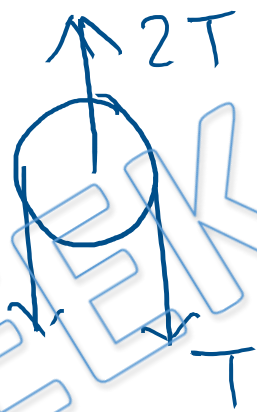

F.B.D of  $P_2$

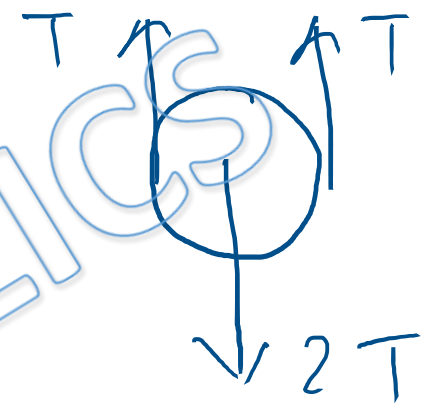

F.B.D of man



F.B.D of block

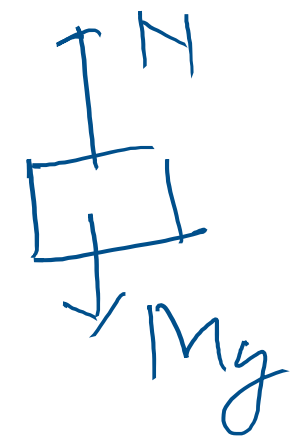

## Solution: 2

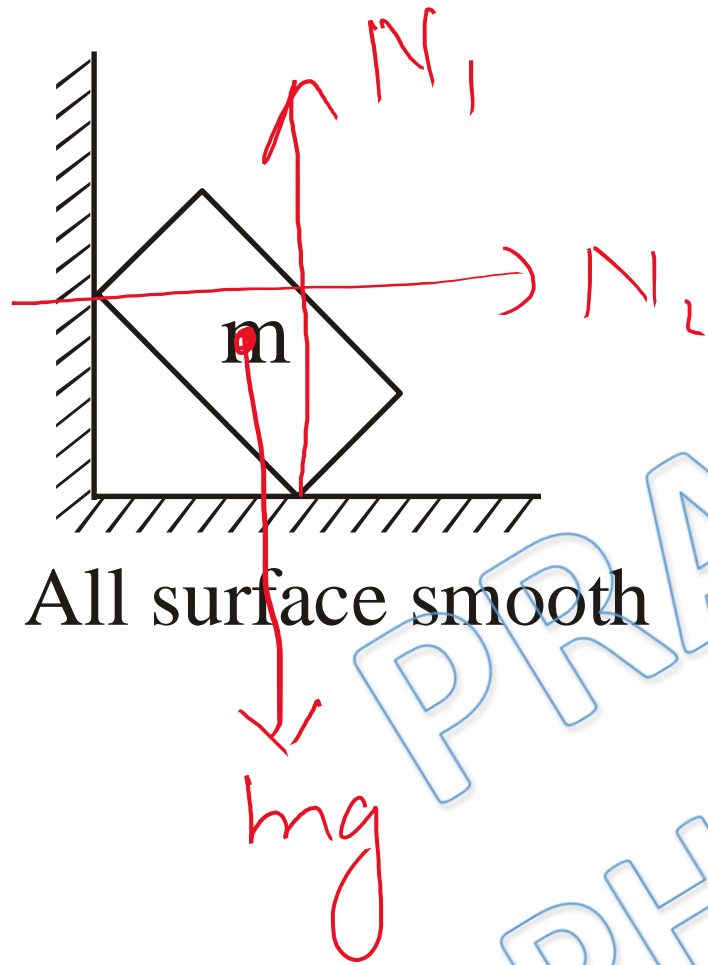

PRATEEK JAIN  
PHYSICSAHOLICS

### Solution: 3

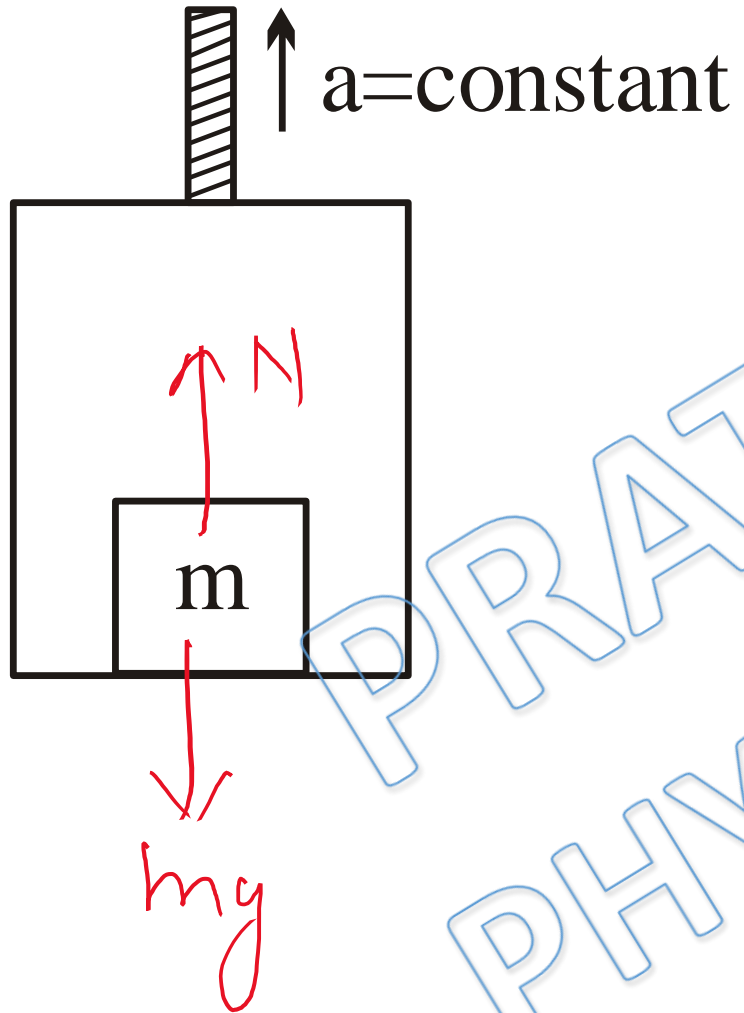

PRATEEK JAIN  
PHYSICSAHOLICS



# Solution: 4

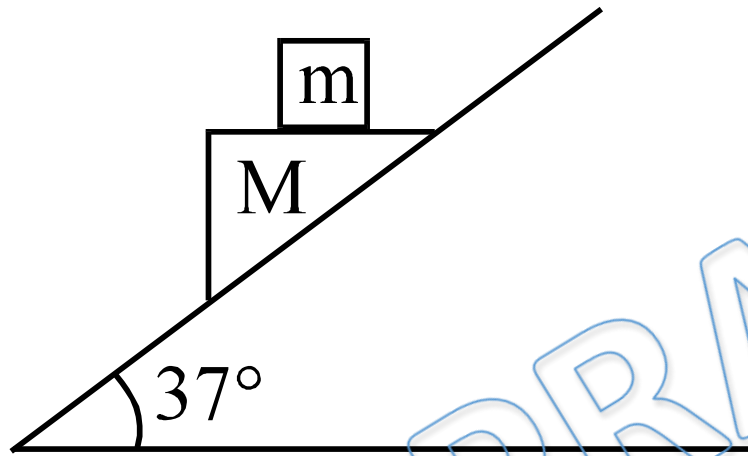

F.B.D of  $m$

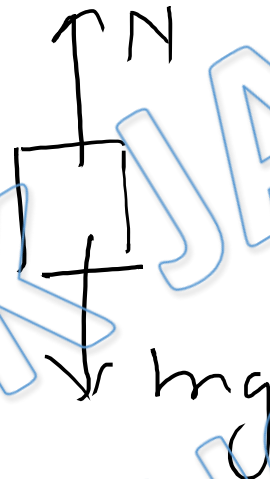

F.B.D of  $M$

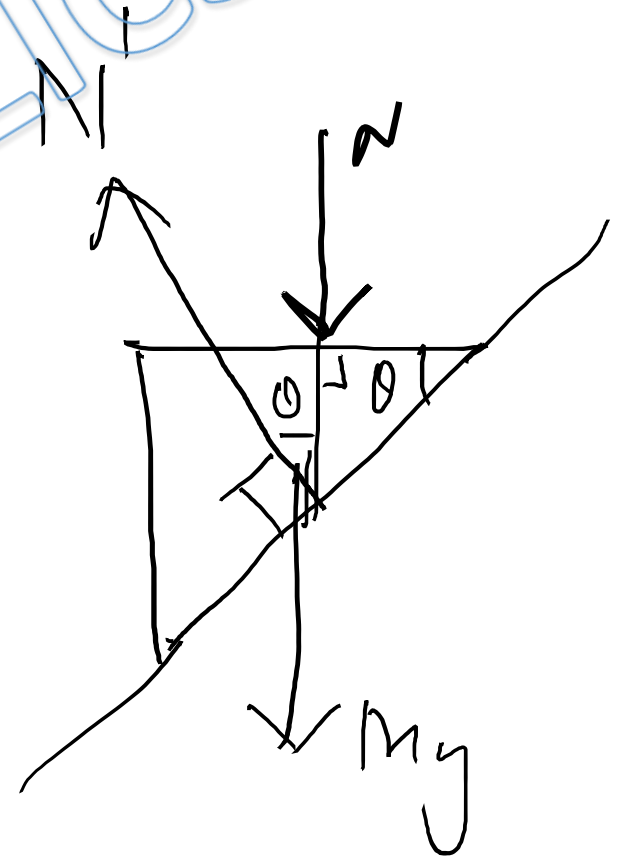

# Solution:5

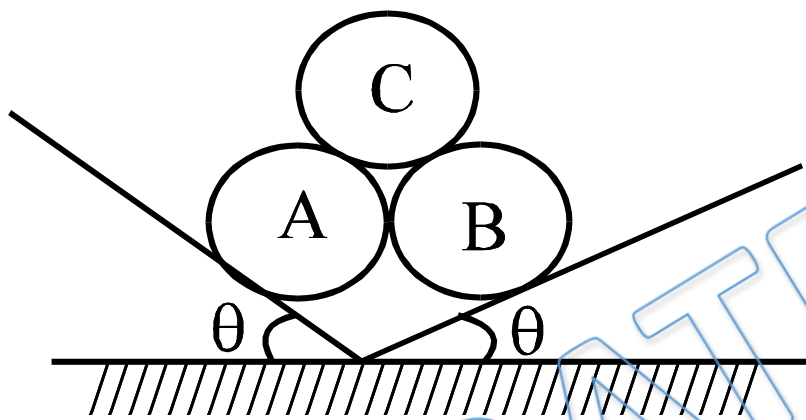

F.B.D of A

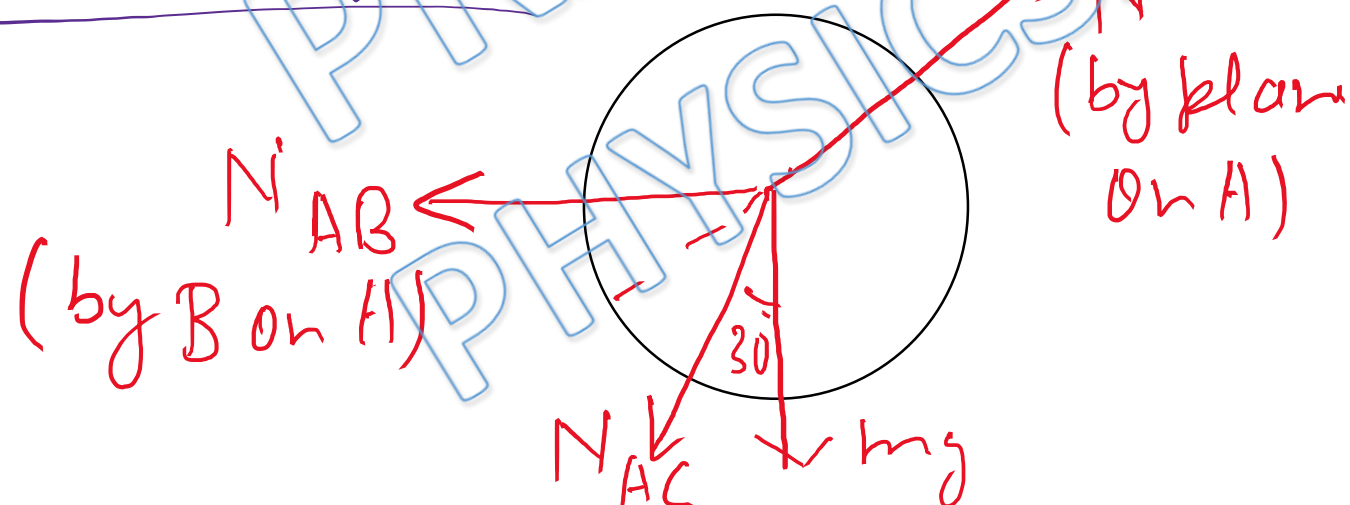

F.B.D of C

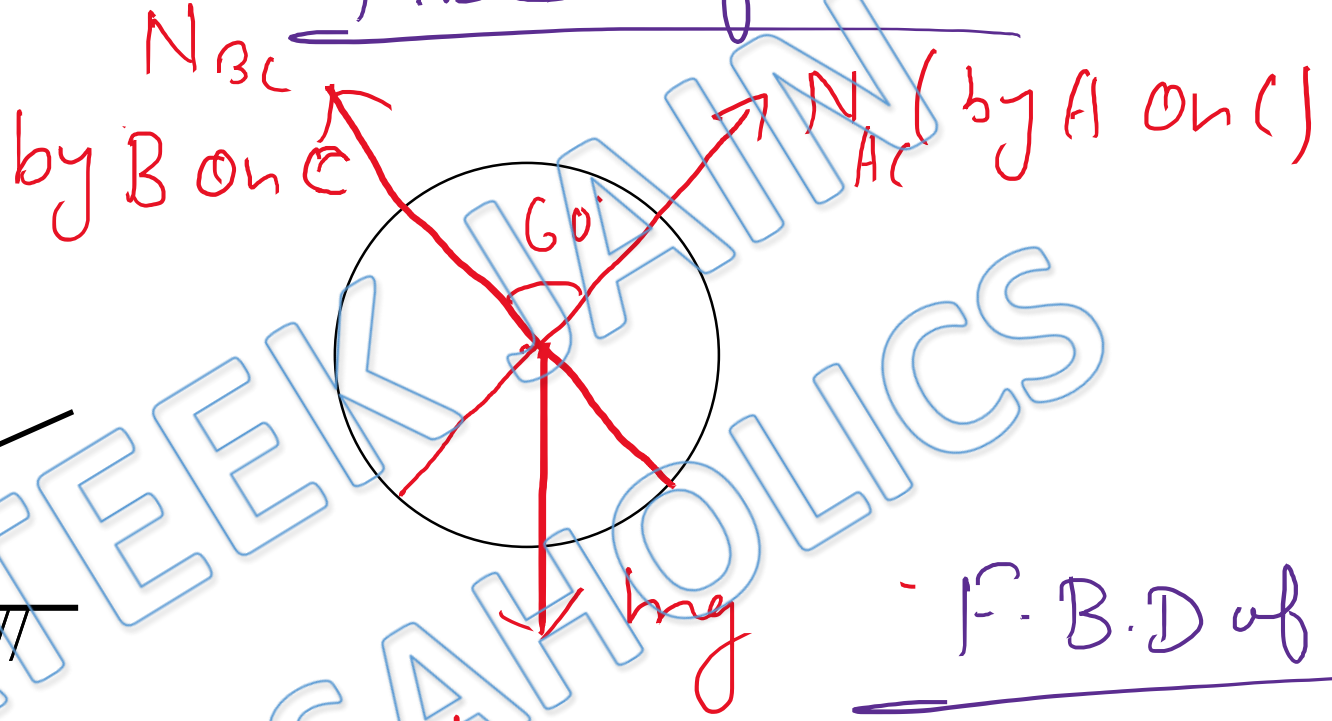

F.B.D of B

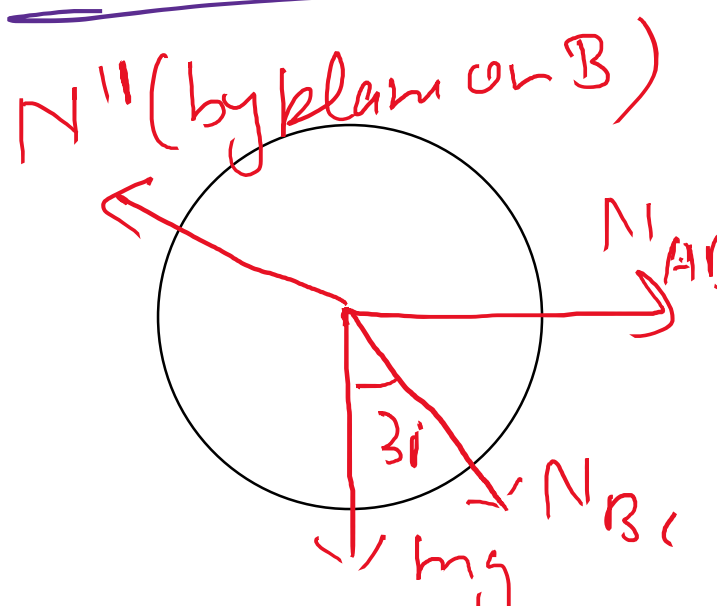

## Solution: 6

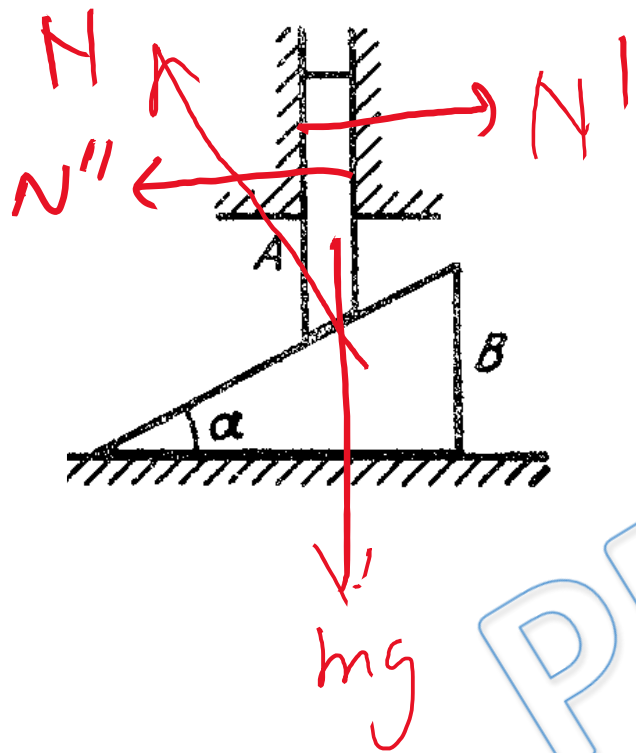

PRATEEK JAIN  
PHYSICSAHOLICS

# Solution:7

F.B.D of man

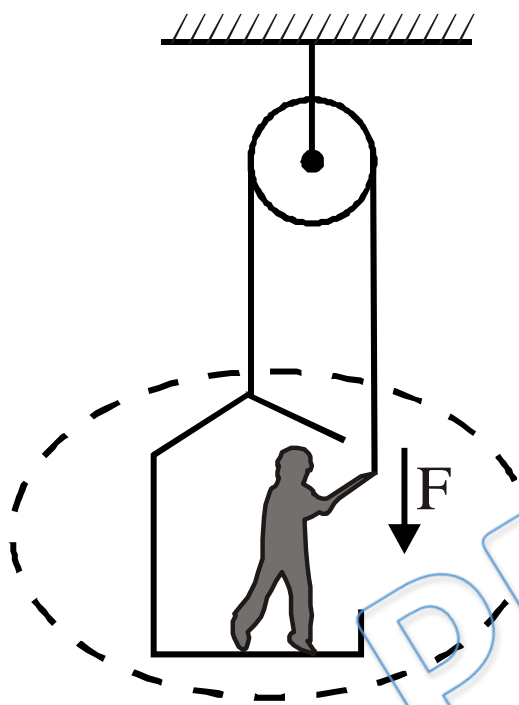

$m = \text{mass of man}$

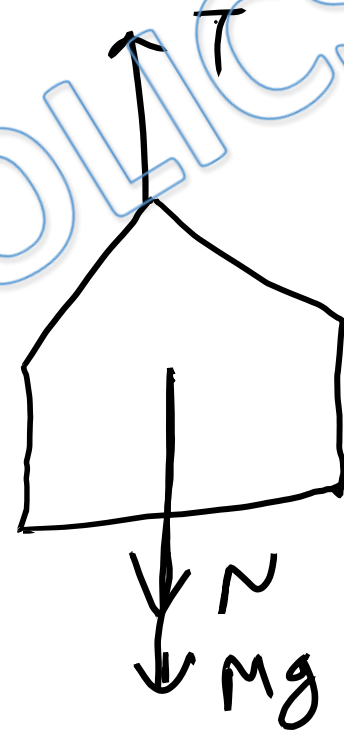

$M = \text{mass of cabin.}$

# Solution:8

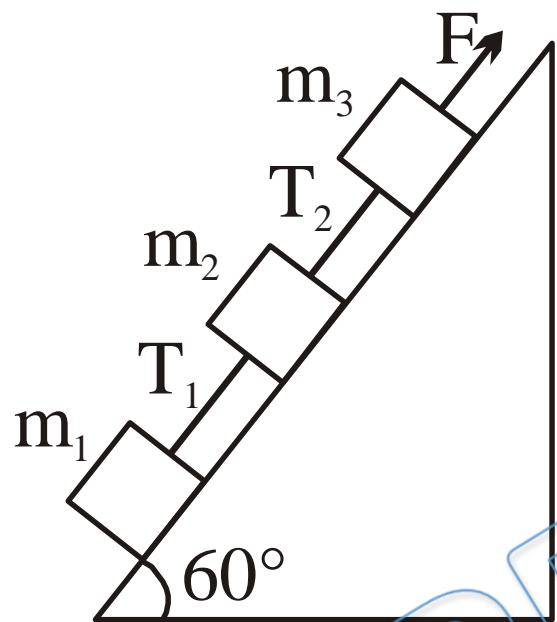

F.B.D of  $m_1$

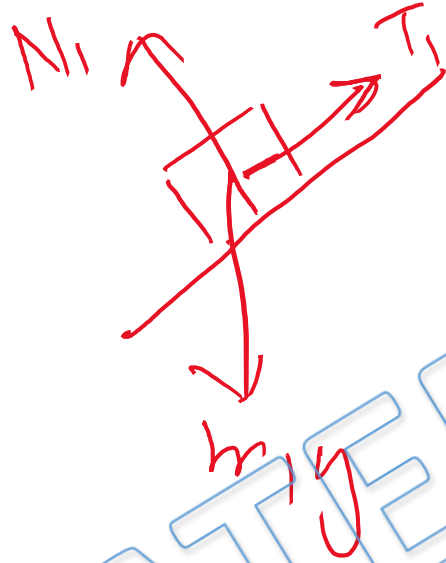

F.B.D of  $m_2$

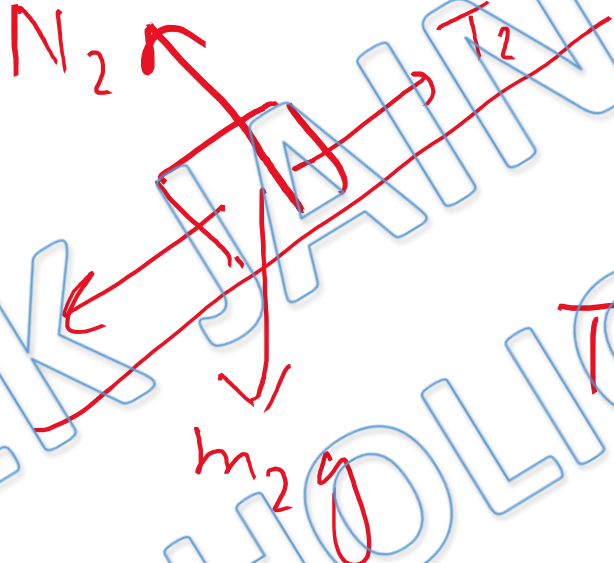

F.B.D of  $m_3$

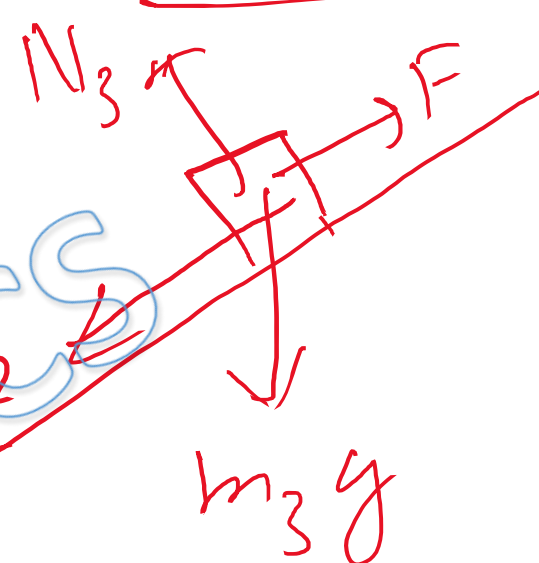

F.B.D of wedge  $\rightarrow$

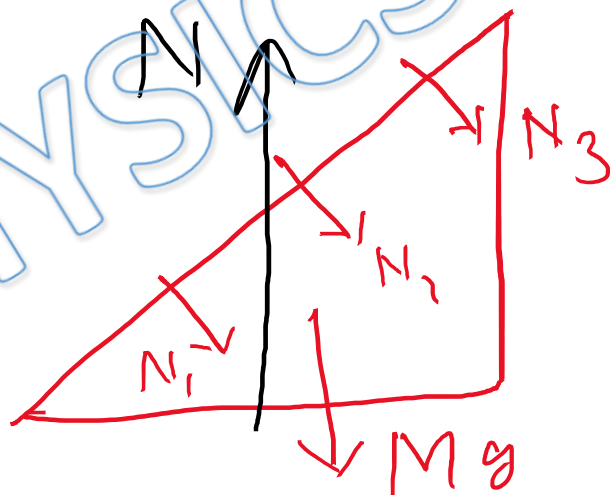

# Solution:9

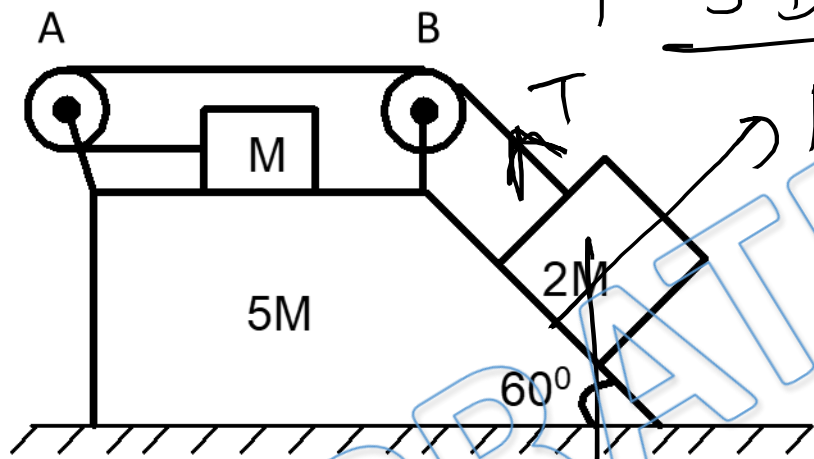

F.B.D of  $2M$

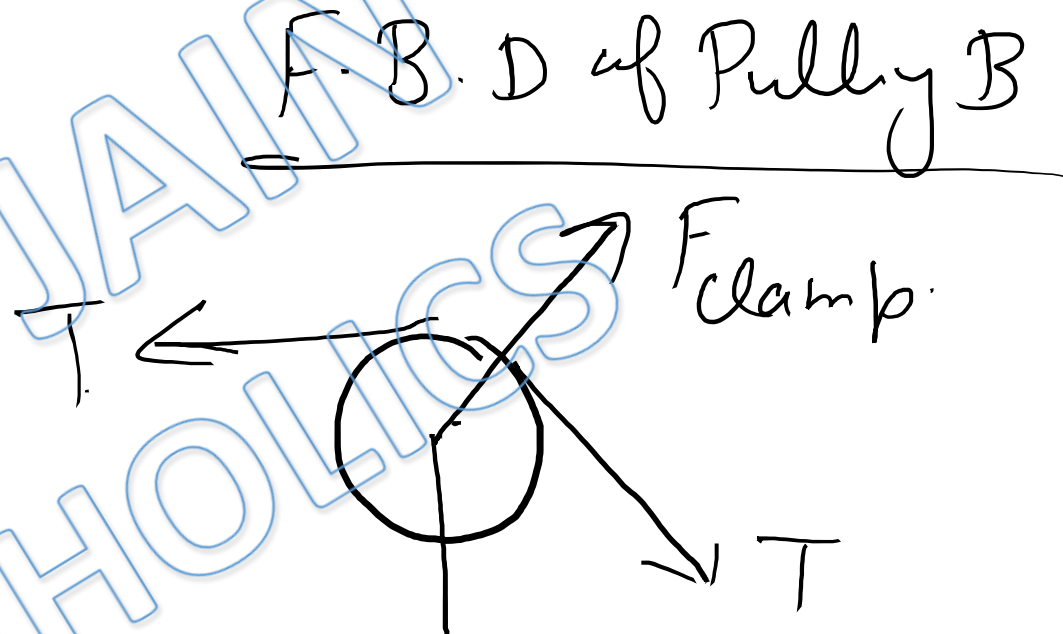

F.B.D of Pulley B

# Solution:10

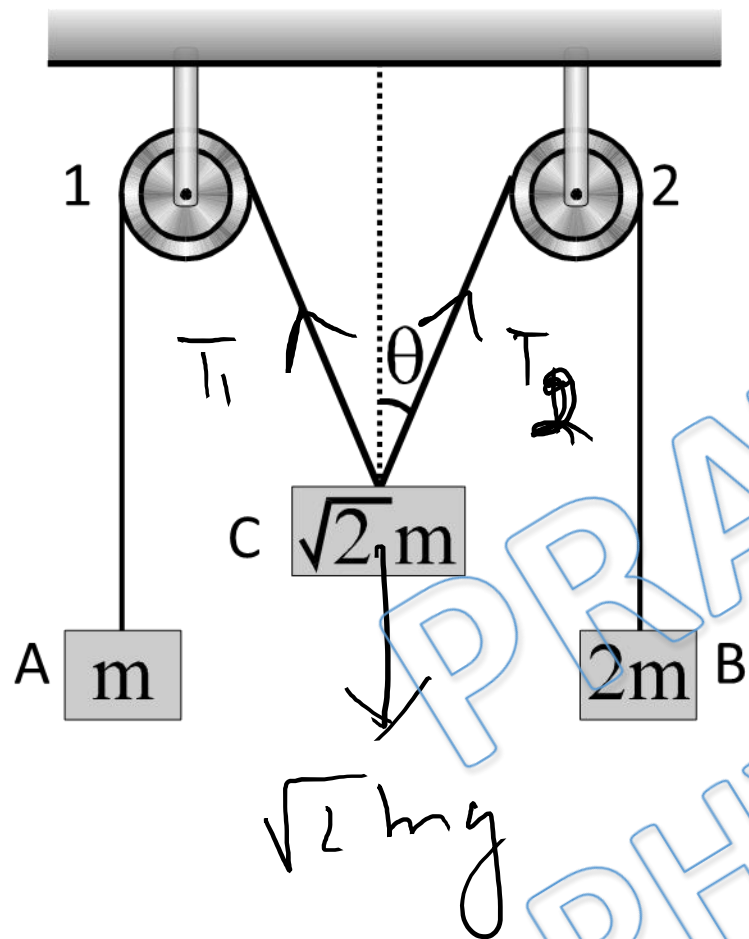

F.B.D of pulley 2

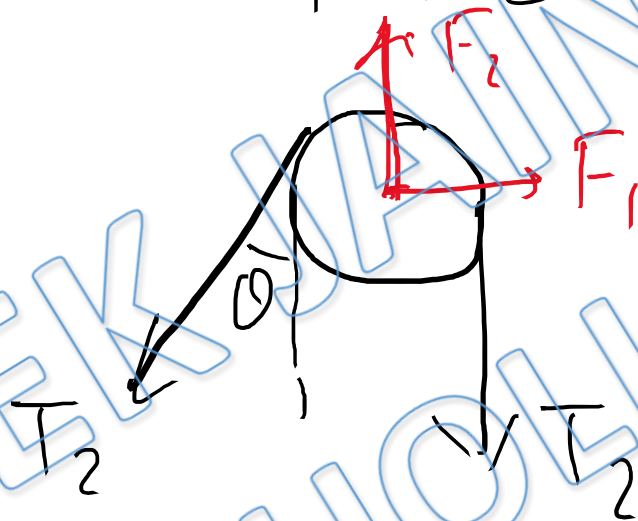

$F_1$  &  $F_2$   
are forces  
by clamp  
on pulley

For Video Solution of this DPP, Click on below link

Video Solution  
on Website:-

<https://physicsaholics.com/home/courseDetails/53>

Video Solution  
on YouTube:-

<https://youtu.be/bzzArA15vcQ>

Written Solution  
on Website:-

<https://physicsaholics.com/note/notesDetails/75>



 **SUBSCRIBE**



[@Physicsaholics](#)

[@Physicsaholics\\_prateek](#)

[@NEET\\_Physics](#)

[@IITJEE-Physics](#)

[physicsaholics.com](#)

[Unacademy](#)



**CLICK**

Chalo Niklo